

# HSF

Table.1: 6362-08MDHSXMCBA1 6362-08MUHSXMCBA1

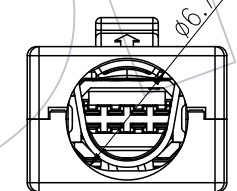
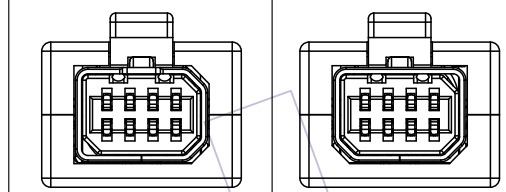
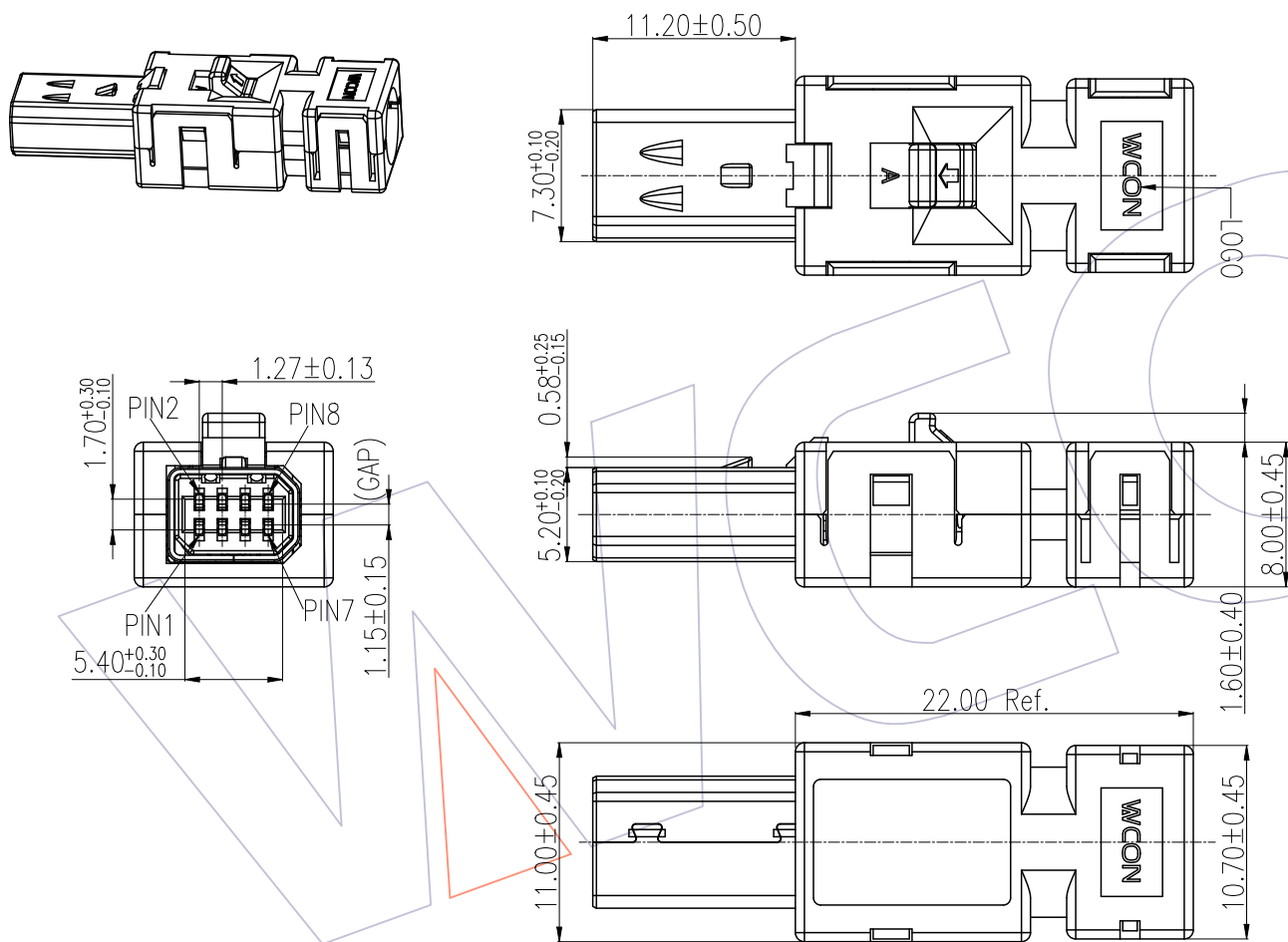

①	Metal Bottom Cover	M6362-08MXMHXX01	1	SPCC,T=0.35,Plated Ni
②	Metal Top Cover	M6362-08MMHXX01	1	SPCC,T=0.35,Plated Ni
③	Plastic Top Cover	G6362-08MXHCBNX	1	ABS+PC,UL94V-0,Black
④	Plastic Bottom Cover	G6362-08MBHCBNX	1	ABS+PC,UL94V-0,Black
⑤	Connector Assemble	B6362-08MHSXAB1	1	C5191-H,T=0.30,Plated Au PBT,UL94V-0,Black
⑥	Cable Clamp	G6362-08MDHABN1	1	PA66,UL94V-0,Black
⑦	Push Rod	G6362-08MHHABN1	1	PBT,UL94V-0,Black
Item	Part Name	Part No.	Qty	Remark

				OPERATION	DRAW	DATE	SCALE	Fit	PART NO.
				x.x ±0.40	Jason	2022/05/10	UNIT	mm	6362-08MXHSXMCBA1
				x.xx ±0.25	CHECK	DATE	SIZE	A4	TITLE:
A0	2022/05/10	NEW RELEASE	Jason	x.xxx ±0.15	Andrey		SHEET	1/3	1.27mm Micro I/O 8P Cable Assembly Connector Solder TYPE.
REV	DATE	MODIFICATION DESCRIPTION	CHANGE	Angle ± 3°	APPROVE	DATE	PROJ.		Customer NO.
				DIM TOL					

**WCON**

Http: [www.wcon.com](http://www.wcon.com)

WCON-Dongguan	WCON-Kunshan
Tel: +86 769 85358920	Tel: +86 512 57468408
Fax: +86 769 85358915	Fax: +86 512 57468468
E-mail: <a href="mailto:sales@wcon.com">sales@wcon.com</a>	E-mail: <a href="mailto:salesks@wcon.com">salesks@wcon.com</a>

HSF

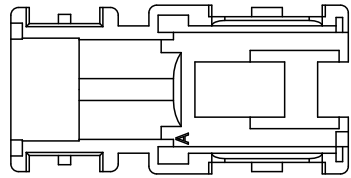
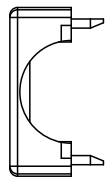
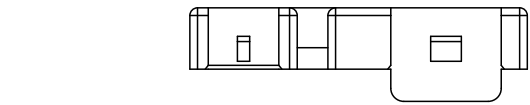

Plastic Top Cover

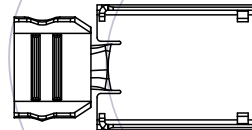
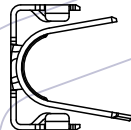
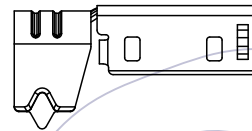

Metal Top Cover

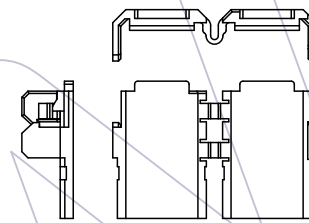

Cable Clamp

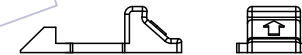
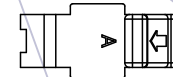

Push Rod

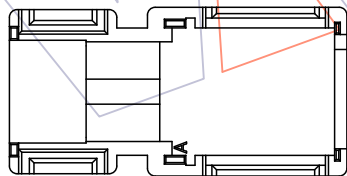
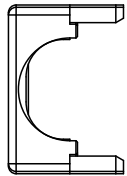
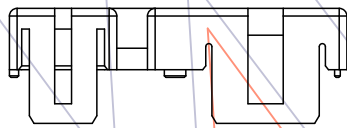

Plastic Bottom Cover

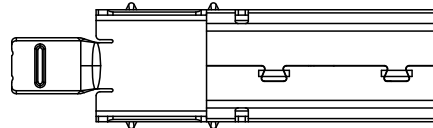
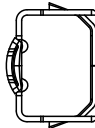
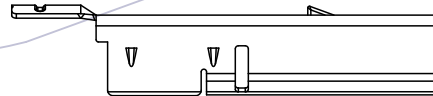

Metal Bottom Cover

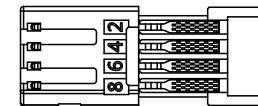
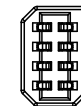

Connector Assemble

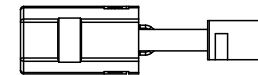

				OPERATION	DRAW	DATE	SCALE	Fit	PART NO.
				x.X ±0.40	Jason	2022/05/10	UNIT	mm	6362-08MXHSXMCBA1
				x.XX ±0.25	CHECK	DATE	SIZE	A4	TITLE:
				x.XXX ±0.15	Andrey		SHEET	2/3	1.27mm Micro I/O 8P Cable Assembly Connector Solder TYPE.
A0	2022/05/10	NEW RELEASE	Jason	Angle ± 3'	APPROVE	DATE	PROJ.	⊕	Customer NO.
REV	DATE	MODIFICATION DESCRIPTION	CHANGE	DIM	TOL				

**WCON**

Http: [www.wcon.com](http://www.wcon.com)

WCON-Dongguan  
Tel: +86 769 85358920  
Fax: +86 769 85358915  
E-mail: [sales@wcon.com](mailto:sales@wcon.com)

WCON-Kunshan  
Tel: +86 512 57468408  
Fax: +86 512 57468468  
E-mail: [salesks@wcon.com](mailto:salesks@wcon.com)

# HSF

## Ordering Information

6362-08 M X H SX M C B A 1

Series Code:  
No. of Pins:  
08=8Pin  
Genre:  
M=Male  
Mating Shape:  
See "Table1"  
Type Code:  
H=Solder TYPE

Internal Code:  
1~9  
Packing:  
A=plastic Box  
Color:  
B=Black  
Plastic Cover Material:  
C=ABS+PC  
Metal Cover Material:  
M=SPCC  
Contact Plating:

S4	Sel.15u"Gold/Tin
S5	Sel.30u"Gold/Tin

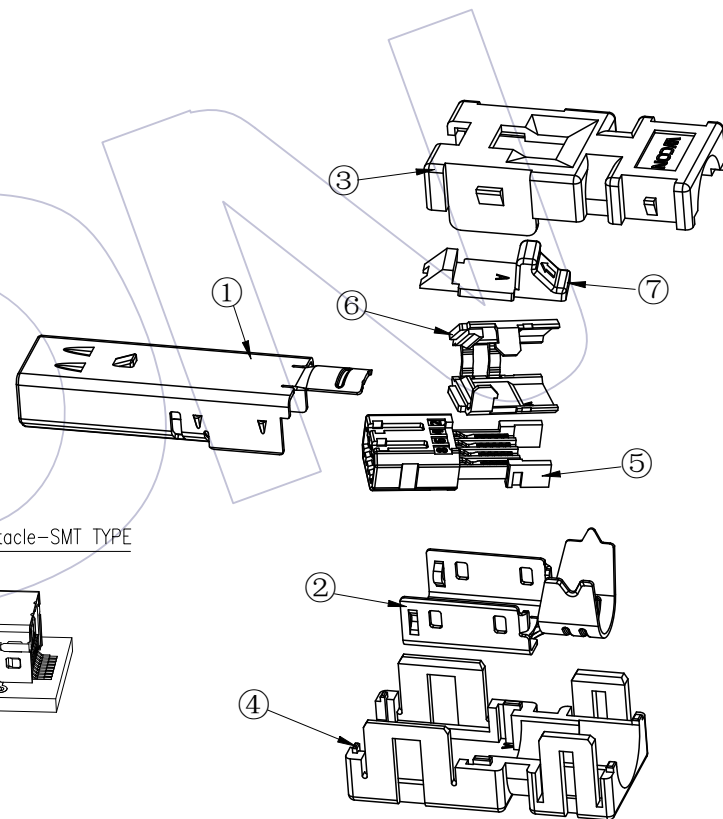
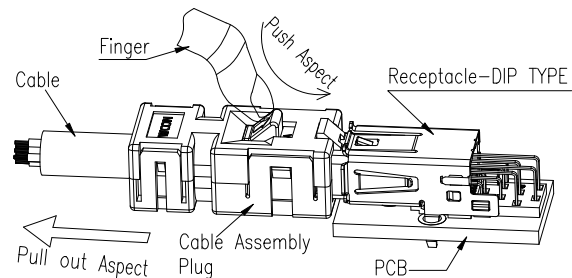
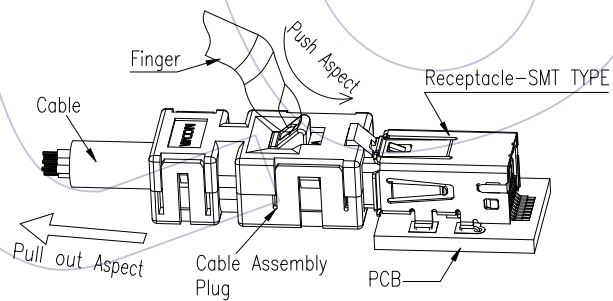
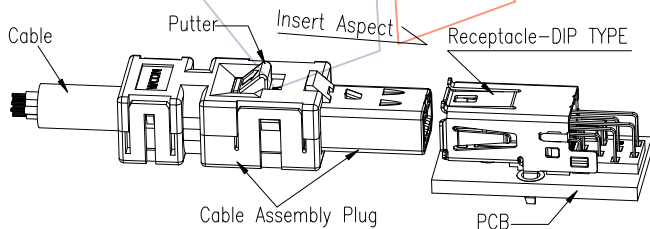
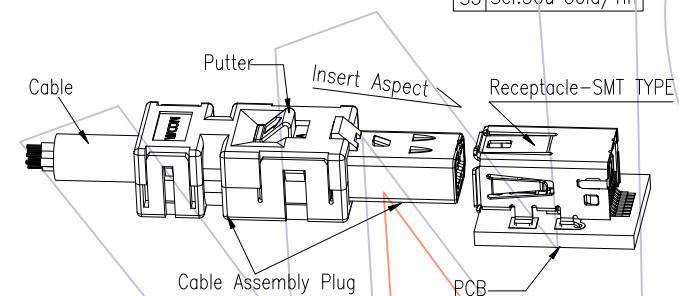

REV	DATE	MODIFICATION DESCRIPTION	CHANGE	OPERATION	DRAW	DATE	SCALE	Fit	PART NO.
A0	2022/05/10	NEW RELEASE	Jason	x.X ±0.40	Jason	2022/05/10	UNIT	mm	6362-08MXHSXMCBA1
				x.XX ±0.25	CHECK	DATE	SIZE	A4	TITLE:
				x.XXX ±0.15	Andrey		SHEET	3/3	1.27mm Micro I/O 8P Cable Assembly Connector Solder TYPE.
				Angle ± 3°	APPROVE	DATE	PROJ.		Customer NO.
				DIM TOL					

# WCON

Http: www.wcon.com

WCON-Dongguan	WCON-Kunshan
Tel: +86 769 85358920	Tel: +86 512 57468408
Fax: +86 769 85358915	Fax: +86 512 57468468
E-mail: sales@wcon.com	E-mail: salesks@wcon.com