

# HSF

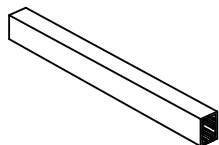

1.27牛角, SMT



No: 1

产品装入真空管内  
SG-A23 (600mm牙型真空管)

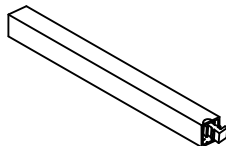

No: 2

塞塑胶塞

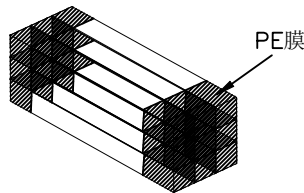

No: 3

20管为一扎(不用摆),先用PE膜固定每扎真空管两端,包住两端利角,以防划破胶袋

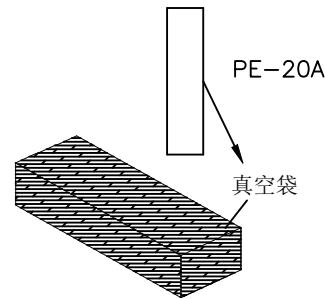

No: 4

将包扎好的真空管(6扎)装入真空袋PE-20A,外加2包干燥剂,机台抽真空

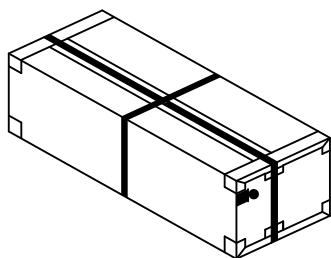

No: 8

打包装带

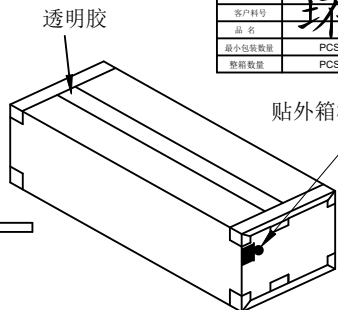

No: 7

封箱及贴标签于外箱侧面的左上角

WCON 伟峰五金电子有限公司			3
成品标示单			
WCON料号	HSF		
客户料号	环保		
品名	PCS	日期	年 月 日
最小包装数量	PCS	制单号	
装箱数量	PCS		

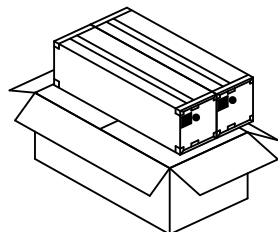

No: 6

内箱放入外箱(2内箱/外箱)  
外箱规格: CTN-10C (65\*33\*19CM)

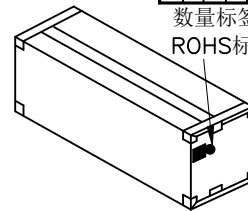

No: 5

将抽真空的产品,放入内箱.  
(120管/内箱),封箱及贴标签于内箱侧面的左上角.内箱规格: CTN-10A (63\*15\*17CM)



数量标签及  
ROHS标签

规格	真空管装数量	每内箱装数量	每外箱装数量	规格	真空管装数量	每内箱装数量	每外箱装数量
6P	31	3720	7440	36P	15	1800	3600
8P	29	3480	6960	38P	15	1800	3600
10P	27	3240	6480	40P	14	1680	3360
12P	26	3120	6240	42P	14	1680	3360
14P	24	2880	5760	44P	13	1560	3120
16P	23	2760	5520	46P	13	1560	3120
18P	22	2640	5280	48P	12	1440	2880
20P	21	2520	5040	50P	12	1440	2880
22P	20	2400	4800	52P	12	1440	2880
24P	19	2280	4560	54P	11	1320	2640
26P	18	2160	4320	56P	11	1320	2640
28P	17	2040	4080	58P	11	1320	2640
30P	17	2040	4080	60P	11	1320	2640
32P	16	1920	3840	62P	10	1200	2400
34P	16	1920	3840	64P	10	1200	2400

说明:

1. 产品如图所示形态放入真空管
2. 注意各标签样式,位置及方向的一致性
3. 打外箱包装带时需注意,打为十字型.

变更记事

版次 REV	日期 DATE	变更说明 MODIFICATION DESCRIPTION	变更 CHANGE	核准 APPROVE
A0	2009/12/21	NEW		

零件图		颜色 COLOR	———	SCALE	fit
X.	±0.50	材质 MATERIAL	———	UNIT	mm
X.X	±0.20	设计 DESING	马云青	SIZE	A4
X.XX	±0.10	审核 CHECK	09/12/21	SHEET	1/1
X.XXX	±0.05	核准 核淮		PROJ.	☉
Angle					
X.	± 2'				
DIM	TOL				

SCALE	fit
UNIT	mm
SIZE	A4
SHEET	1/1
PROJ.	☉

## WCON

WCON Hardware Electronics Co., Ltd

料号 PART NO. 3231-XXMXXXXTX

品名 TITLE: 1.27 牛角 S型 SMT短耳扣 包装规范