

HSF

NOTES:
 Rated Current: 15 AMP
 Contact Resistance: 8 mΩ Max
 Withstand Voltage: 2000 V AC/DC
 Insulation Resistance: 1000 MΩ min
 Operation Temperature: -40°C to +105°C
 Wire Range: 30~12 AWG
 Wire Strip Length: 7 mm
 Screw Counter Torsion Force: 4.4 lbf.in Min.

Ordering Information:

P F 750 - B XX A SM W 1 N

F=Female Pitch 750=7.50 No. of Pins 02-20P Contact Plated SM=Matte Tin Blank=W/T WCON Logo N=W/O WCON Logo
 Color A=Green Type W=With Screw

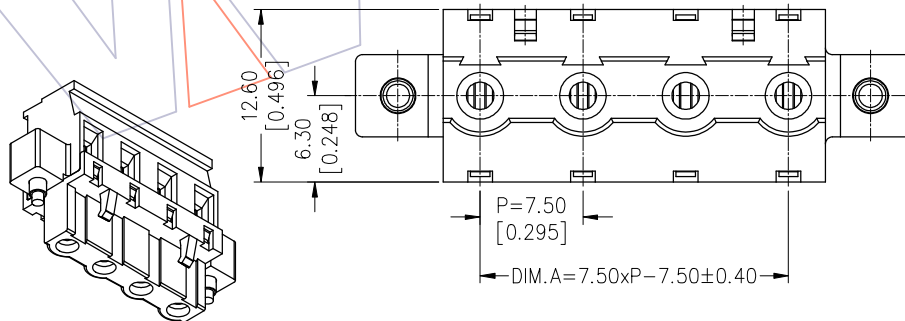
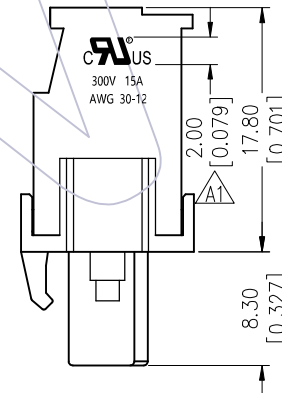
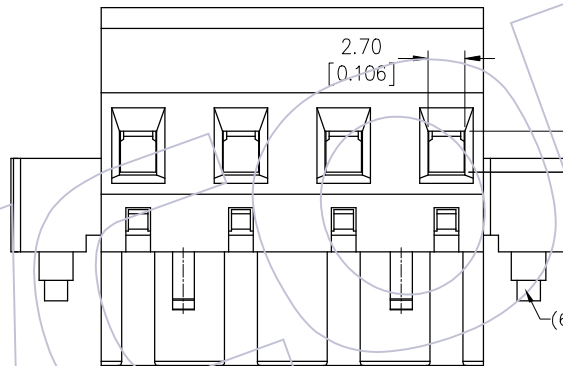
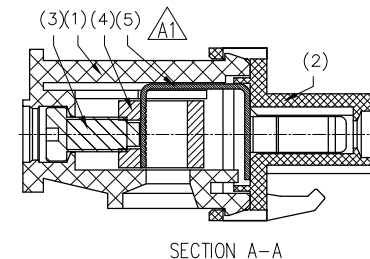
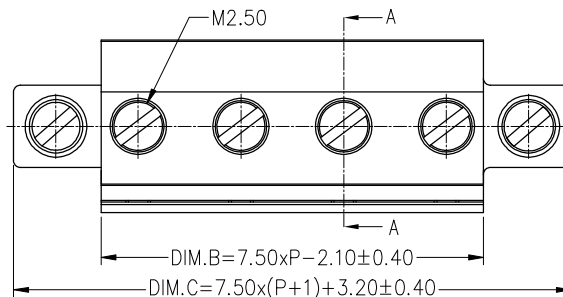
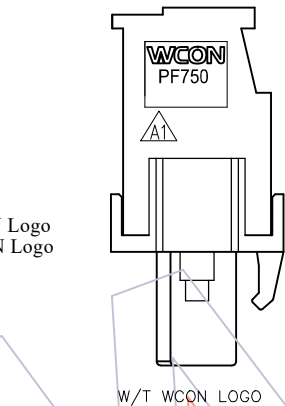
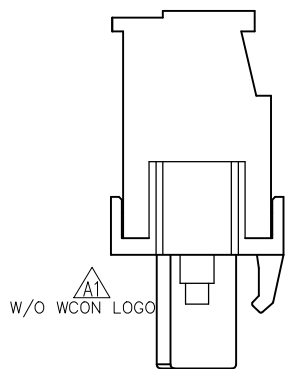

PIN	DIM.A	DIM.B	DIM.C	PIN	DIM.A	DIM.B	DIM.C
02	7.50	12.90	25.70	12	82.50	87.90	100.70
03	15.00	20.40	33.20	13	90.00	95.40	108.20
04	22.50	27.90	40.70	14	97.50	102.90	115.70
05	30.00	35.40	48.20	15	105.00	110.40	123.20
06	37.50	42.90	55.70	16	112.50	117.90	130.70
07	45.00	50.40	63.20	17	120.00	125.40	138.20
08	52.50	57.90	70.70	18	127.50	132.90	145.70
09	60.00	65.40	78.20	19	135.00	140.40	153.20
10	67.50	72.90	85.70	20	142.50	147.90	160.70
11	75.00	80.40	93.20				

ITEM	TITLE	P/N	Q'TY	Material
(6)	Screw-2	MC025-1SXX01	2	C1018
(5)	Contact	TPT051-PSM001	N	C5191R-H T=0.4
(4)	Pin Block	BL025-1SNI01	N	C3604
(3)	Screw	MA025-1SXX01	N	C1018
(2)	Cover	HPC750-XXB1AN2	1	PA66 UL94-V0
(1)	Housing	HPF750-XXB1AW2(N)	1	PA66 UL94-V0

REV	DATE	MODIFICATION DESCRIPTION	CHANGE	OPERATION	DRAW	DATE	SCALE	FIT	PART NO.
				X.X	±0.40	2020/08/04	UNIT	mm	PF750-BXXASM1(N)
A1	2020/08/04	ADD LOGO; ADD W/O WCON LOGO P/N	XSR	X.XX	±0.25	DATE	SIZE	A4	TITLE:
A0	2013/11/08	NEW	Tsingsn	X.XXX	±0.15	DATE	SHEET	1/1	7.50mm Pitch Female Pluggable Terminal Blocks
				Angle	± 3°	DATE	PROJ.		Customer NO.
				DIM	TOL				

WCON

Http: www.wcon.com

WCON-Dongguan
 Tel: +86 769 85358920
 Fax: +86 769 85358915
 E-mail: sales@wcon.com

WCON-Kunshan
 Tel: +86 512 57468408
 Fax: +86 512 57468468
 E-mail: salesk@wcon.com