

HSHF

Tail part(Empty)
160mm Min.

Ⓐ 端留空至少160mm

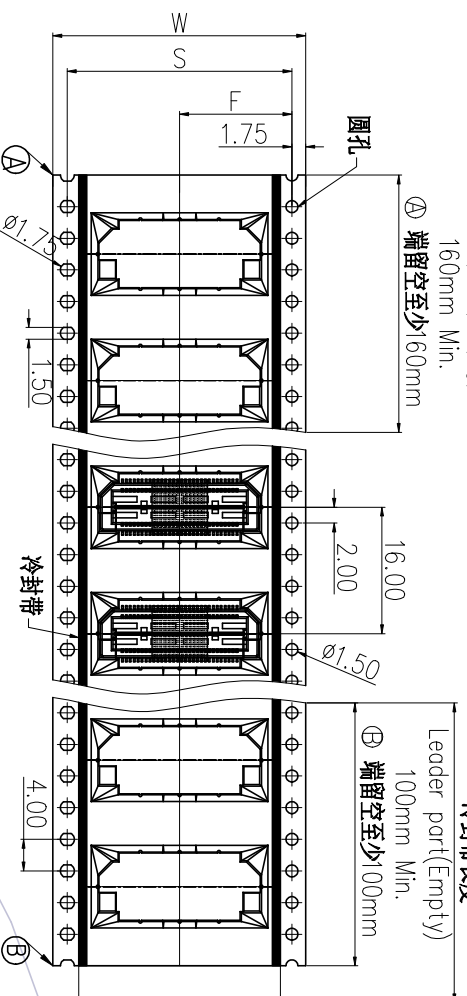

400mm Min.
Top tape length
冷封带长度

Leader part(Empty)
100mm Min.

Ⓑ 端留空至少100mm

包装时产品卷入方向

客户安装时拉出方向
Customer pull out direction

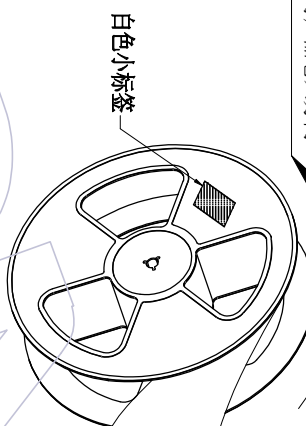

No.1:
产品包装前,注意载带要留空160mm以上
将产品放入载带凹槽后,用盖带封装,
注意:盖带与承载带的拉力30g~120g

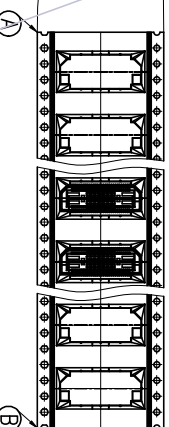

环保大标签
黄色打包带

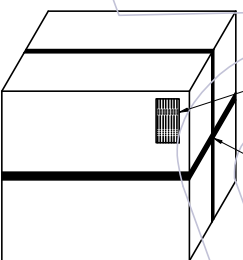

外箱: CTN-18K

No.4:
封箱, 打包, 贴标签。

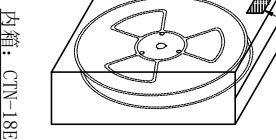
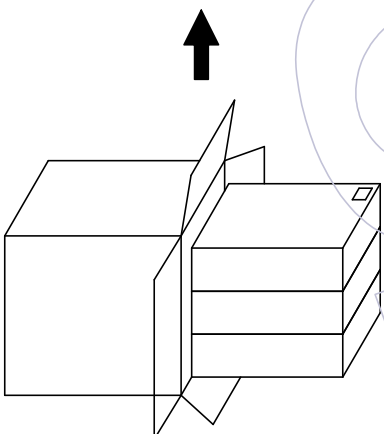

内箱: CTN-18E

No.3:
将内箱装入外箱(3内箱/外箱)
注意统一标签方向

No.2:
将卷盘套上PE-32防水袋,
放入1包干燥剂,
真空机封口后装入内箱,
用封箱胶封装好,并贴上标签。

PN	载带料号	W	S	F	PCS/Reel	PCS/内箱	PCS/外箱
60	TR37202-MNN060M05601	32.0±0.30	28.40±0.15	14.20±0.15	650	1300	3900
120	TR37202-MNN120M05601	56.0±0.30	52.40±0.15	26.20±0.15	650	650	1950
180	TR37202-MNN180M05601	88.0±0.30	84.40±0.15	42.20±0.15	650	650	1950
240	TR37202-MNN240M05601	104.0±0.30	100.40±0.15	50.20±0.15	650	650	1950

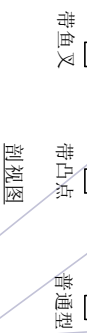

变更日期	变更日期	变更说明	变更	变更	变更
REV	DATE	DESCRIPTION	CHANGE	APPROVE	APPROVE
A0	2022/07/13	NEW			

工程图		绘图		SCALE	
ENGINEERING	DRAW	设计	审核	UNIT	FIT
X.X	±0.20	设计	审核	mm	
X.XX	±0.20	DESIGN	CHECK	A4	
X.XXX	±0.10	CHECK		SHEET	1/1
Angle	± 2°	核准		PROJ.	
DIM	TOL	核准			

WCON ELECTRONICS (GUANGDONG) CO., LTD	
料号	品名
PART NO.	TITLE:
37201 (2) (3) -PMXXX-042XXR01	0.5mm 高速BTB XYP SMT公座, 贴麦拉
	H=4.26, 可带鱼叉, 可带凸点, 卷装规范

WCON

1 2 3 4 5 6 7 8 9 10

H G F E D C B A