

HSF

NOTES:

- 1.Current Rating:2A Max (only one pin) ;
- 2.Voltage Rating:225V DC;
- 3.Contact Resistance:30mΩ Max;
- 4.Withstand Voltage:675V AC;
- 5.Insulation Resistance:5000MΩ Min;
- 6.Operating Temperature: -55°C to +125°C;
- 7.Insulator Material: LCP,G.F,UJ94V-O,BK;
- 8.Contact Material:Copper Alloy;
- 9.Contact plating:
Au on contact area (See ordering information),
100μ" Matte TIN on solder area,
50μ" Nickel underplating overall;
- 10.Recommended process:
Wavesolder,Peak temperature:260±5°C, 5s ;

Ordering Information

37 5 1 X- S M XXX XXX XX X XX

OPTIONS J

- 1=A
- 2=LC
- 3=FL
- S=SOCKET
- M=180° SMT

WCON INTERNAL CODE

PACKAGING
A=VACUUM BOX
R=TAPE&REEL

PLATING
W1=SEL.3U"GOLD/MATTE SN
W3=SEL.10U"GOLD/MATTE SN
W5=SEL.3QU"GOLD/MATTE SN

No OF POSITIONS
040=40PIN
080=80PIN
120=120PIN
160=160PIN
200=200PIN

LEAD STYLE
032=3.25

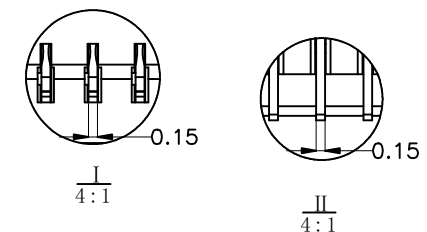
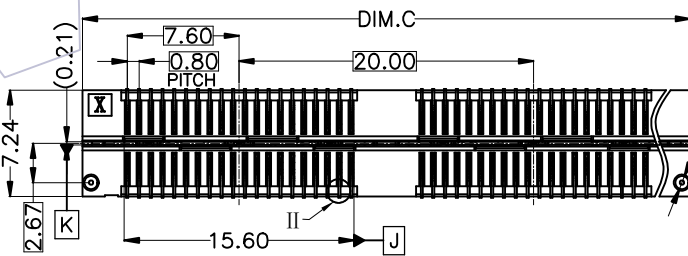
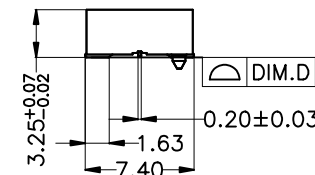
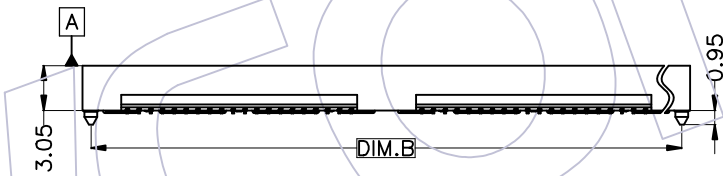
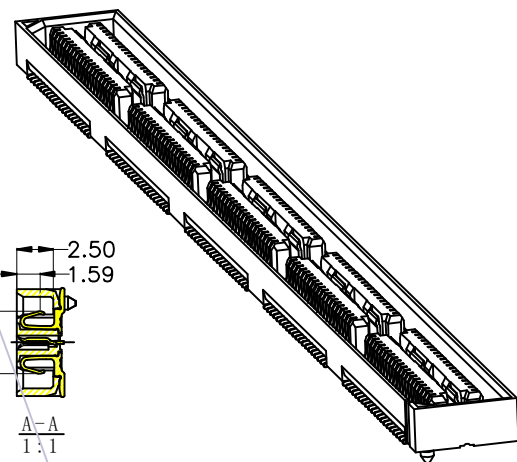
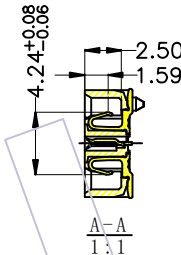
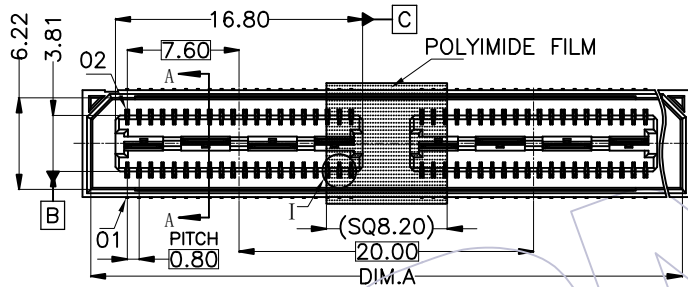

				OPERATION	DRAW	DATE	SCALE	Fit	PART NO. 3751X-SMXXX-032XXX01
				x.x ±0.40	Abt Chen	2022.06.30	UNIT	mm	
				x.xx ±0.25	CHECK	DATE	SIZE	A4	TITLE: 0.8mmB0 TO B0 SOCKET SMT, H=3.25, ASSEMBLY
				x.xxx ±0.15	APPROVE	DATE	SHEET	1/4	Customer NO.
A0	2022.06.30	NEW		Angle ± 3'			PROJ.		
REV	DATE	MODIFICATION DESCRIPTION	CHANGE	DIM TOL					

WCON

Http: www.wcon.com

WCON-Dongguan
Tel: +86 769 85358920
Fax: +86 769 85358915
E-mail: sales@wcon.com

WCON-Kunshan
Tel: +86 512 57468408
Fax: +86 512 57468468
E-mail: salesks@wcon.com

HSF

SPECIFICATION&SIZE LIST

OPTIONS	P/N	PIN	DIM.A	DIM.B	DIM.C	DIM.D	DIM.E
-A (CONVENTION)	37511-SM040-032XXX01	2*20	20.18	20.13	21.27	0.10	
	37511-SM080-032XXX01	2*40	40.18	40.13	41.27	0.10	
	37511-SM120-032XXX01	2*60	60.18	60.13	61.27	0.15	
	37511-SM160-032XXX01	2*80	80.18	80.13	81.27	0.15	
	37511-SM200-032XXX01	2*100	100.18	100.13	101.27	0.15	
-LC (LOCKING CLIPS)	37512-SM040-032XXX01	2*20	20.18	20.13	21.27	0.10	
	37512-SM080-032XXX01	2*40	40.18	40.13	41.27	0.10	
	37512-SM120-032XXX01	2*60	60.18	60.13	61.27	0.15	
	37512-SM160-032XXX01	2*80	80.18	80.13	81.27	0.15	
	37512-SM200-032XXX01	2*100	100.18	100.13	101.27	0.15	
-FL (FRICTION LOCKS)	37513-SM040-032XXX01	2*20	20.18	20.13	21.27	0.10	20.25
	37513-SM080-032XXX01	2*40	40.18	40.13	41.27	0.10	40.25
	37513-SM120-032XXX01	2*60	60.18	60.13	61.27	0.15	60.25
	37513-SM160-032XXX01	2*80	80.18	80.13	81.27	0.15	80.25
	37513-SM200-032XXX01	2*100	100.18	100.13	101.27	0.15	100.25

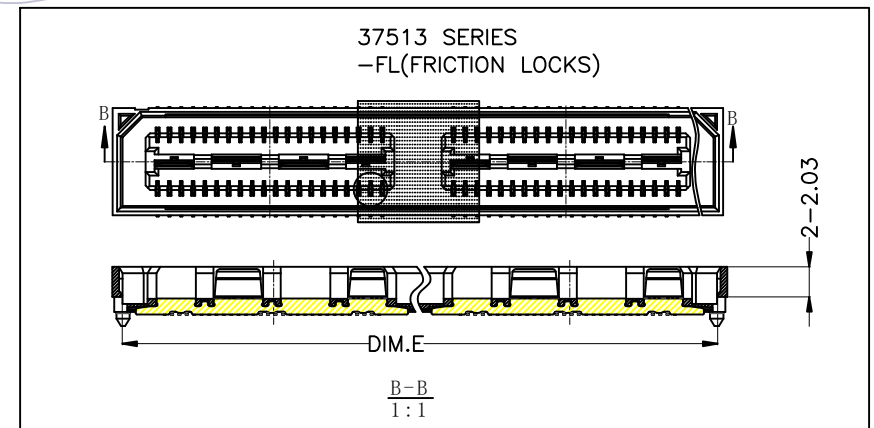
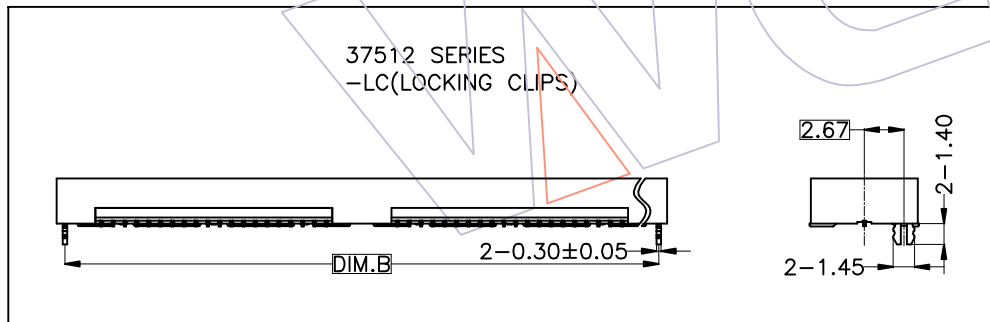

REV	DATE	MODIFICATION DESCRIPTION	CHANGE	OPERATION	DRAW	DATE	SCALE	Fit	PART NO.
AO	2022.06.30	NEW		x.x ±0.40	Abt Chen	2022.06.30	UNIT	mm	3751X-SMXXX-032XXX01
				x.xx ±0.25	CHECK	DATE	SIZE	A4	TITLE:
				x.xxx ±0.15	APPROVE	DATE	SHEET	2/4	0.8mmB0 TO B0 SOCKET SMT, H=3.25, ASSEMBLY
				Angle ± 3°			PROJ.	⊕	Customer NO.
				DIM TOL					

WCON

Http: www.wcon.com

WCON-Dongguan Tel: +86 769 85358920 Fax: +86 769 85358915 E-mail: sales@wcon.com	WCON-Kunshan Tel: +86 512 57468408 Fax: +86 512 57468468 E-mail: salesks@wcon.com
---	--

HSF

MATED HEIGHT

MATED HEIGHT	SOCKET HEIGHT	MALE HEIGHT	DEVELOPMENT STATUS
5.00	3.25	4.26	YES
8.00	3.25	7.26	YES
11.00	3.25	10.26	YES
14.00	3.25	13.26	YES
15.00	3.25	14.26	YES
16.00	3.25	15.24	YES
19.00	3.25	18.24	NEXT
22.00	3.25	21.24	NEXT
25.00	3.25	24.24	NEXT
30.00	3.25	29.24	NEXT

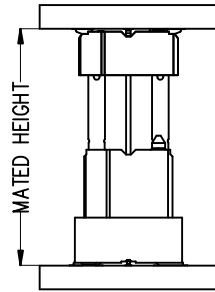

LENGTH SPECIFICATION DISPLAY

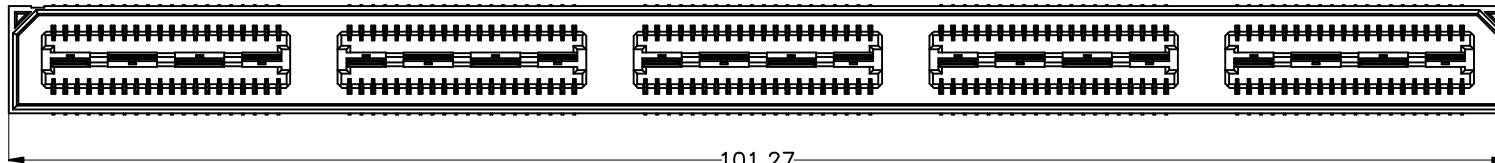
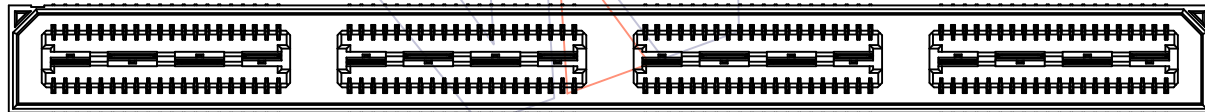
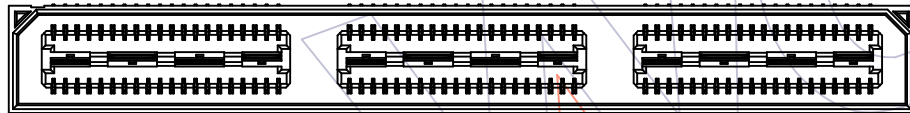
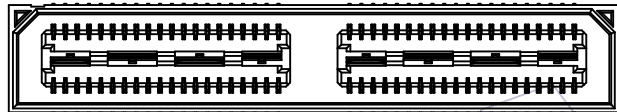
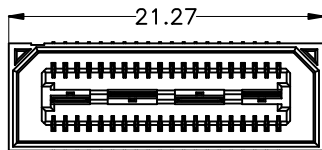

REV	DATE	MODIFICATION DESCRIPTION	CHANGE	OPERATION	DRAW	DATE	SCALE	Fit	PART NO.
A0	2022.06.30	NEW	—	x.x ±0.40	Abt Chen	2022.06.30	UNIT	mm	3751X-SMXXX-032XXX01
				x.xx ±0.25	CHECK	DATE	SIZE	A4	TITLE:
				x.xxx ±0.15	APPROVE	DATE	SHEET	3/4	0.8mmB0 TO B0 SOCKET SMT, H=3.25, ASSEMBLY
				Angle ± 3°			PROJ.	⊕	Customer NO.
				DIM TOL					

WCON

Http: www.wcon.com

WCON-Dongguan
Tel: +86 769 85358920
Fax: +86 769 85358915
E-mail: sales@wcon.com

WCON-Kunshan
Tel: +86 512 57468408
Fax: +86 512 57468468
E-mail: salesks@wcon.com

HSF

RECOMMENDED PCB LAYOUT (COMPONENT SIDE)
TOLERANCE ±0.05

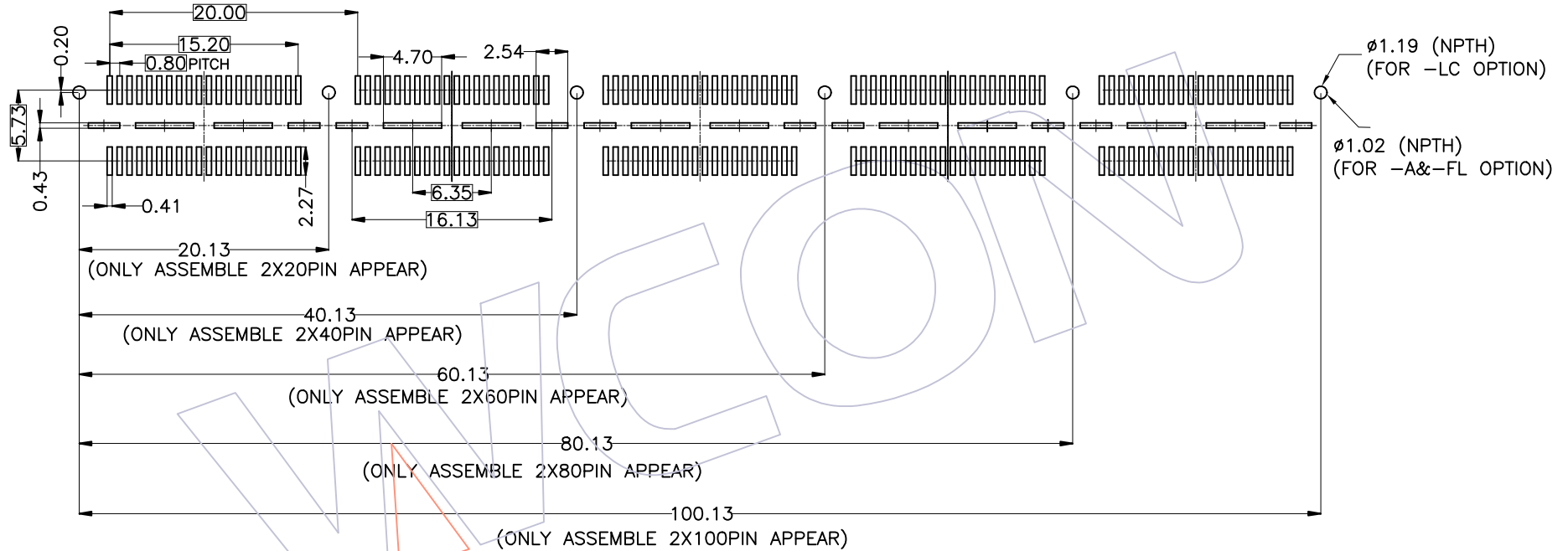

REV	DATE	MODIFICATION DESCRIPTION	CHANGE	OPERATION	DRAW	DATE	SCALE	Fit	PART NO.
				x.x ±0.40	Abt Chen	2022.06.30	UNIT	mm	3751X-SMXXX-032XXX01
				x.xx ±0.25	CHECK	DATE	SIZE	A4	TITLE:
A0	2022.06.30	NEW	—	x.xxx ±0.15	APPROVE	DATE	SHEET	4/4	0.8mmB0 TO B0 SOCKET SMT, H=3.25, ASSEMBLY
				Angle ± 3°			PROJ.	⌀	Customer NO.
				DIM TOL					

WCON
Http: www.wcon.com

WCON-Dongguan Tel: +86 769 85358920 Fax: +86 769 85358915 E-mail: sales@wcon.com	WCON-Kunshan Tel: +86 512 57468408 Fax: +86 512 57468468 E-mail: salesks@wcon.com
---	--