

WD6000 Series

6.00mm pitch/Wire-to-board Connector

WD6000系列

6.00mm间距/线到板连接器

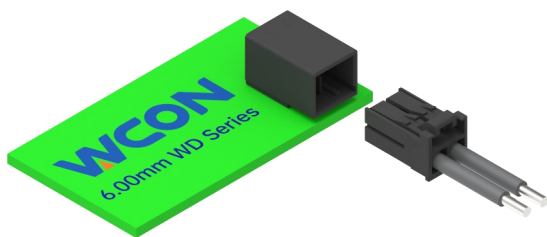

Overview

6.00mm pitch wire-to-board connectors. This series offers a comprehensive solution for signal and power connections. Utilizing a new high-conductivity gold-plated copper material, each pin can handle currents up to 24A.

概述

6.00mm间距线到板连接器。是一款可提供从信号到电源连接的综合解决方案；针对该系列产品的材质，特别采用了新型高导电和金铜，使得该产品单个Pin位可承载电流高达24A。

Features and Benefits

- Anti-misplug structure
- Supports high-current transmission (24A), withstanding up to 2200V AC
- Three-contact terminal box design for vibration-resistant performance
- Single-ear clip push-to-release mechanism for simple, convenient operation

产品特点

- 防错插结构设计
- 支持大电流传输（24A），耐压可达到2200V AC
- 端子三触点盒型结构设计，适应各种震动环境
- 单耳扣按压分离设计，操作简单便捷

Product Applications

- Industrial: Semiconductor manufacturing equipment, servo drives, CNC machine tools, laser cutting machines
- Services: Elevators, escalators, air conditioning, lighting control

应用领域

- 工业：半导体制造设备、伺服驱动器、数控机床、激光切割机
- 服务：电梯、扶梯、空调、照明控制

Standard 标准

- EIA-364, QC/1067

UL certification UL认证

- E248993

Material 材料

Part/零件	Material/材料	Finish/电镀	UL Flame retardant/阻燃等级
Housing/主体	PBT	Black/黑色	UL94V-0
Header/板端	PBT	Black/黑色	UL94V-0
Terminal/端子	Copper alloy 铜合金	Gold-plated/镀金 Tin-plated/镀锡	/

Production Specifications 产品规格

Current rating 额定电流	24.0A	Operating Temperature Range:-55°C~+105°C (including temperature rise) Operating Humidity Range:20-80% 工作温度范围: -55°C~+105°C(含温升) 工作湿度范围: ≤80%	Storage temperature: Humidity: 储存温度: 25±5°C 储存湿度: ≤60%
Voltage rating 额定电压	600V		

Item 项目	Condition 条件	Specification 规格
Insulation Resistance 绝缘电阻	Measured at 1000V DC for 1 minute 测试电压: 1000V DC/1分钟	No less than 1000MΩ 不少于1000MΩ
Withstanding voltage 耐电压	Measured at 2200V AC for 1 minute 测试电压: 2200V AC/1分钟	No breakdown, no discharge, leakage current <0.5 mA 无击穿、无放电、漏电流<0.5 mA
Contact Resistance 接触电阻	Measured at 100mA and no higher than 20mV 用20 mV DC进行测量	Contact resistance: Initial value/ 5 mΩ max After environmental tests/ 10 mΩ max. 接触电阻: 初始值 5 mΩ 以下 测试后 10 mΩ 以下
Vibration Resistance 抗振动	Vibration Frequency: 10-500Hz Test Acceleration: 98m/s ² Test Amplitude: 1.52mm Vibration Direction and Duration: 3 hours each in X-axis, Y-axis, and Z-axis directions 震动频率: 10-500Hz 测试加速度: 98m/s ² 测试振幅: 1.52mm 振动方向及时间: X 轴, Y 轴, Z 轴方向各工作 3 小时	No electrical discontinuity greater than 1μS. Shall occur 测试过程中不得出现大于1μS瞬断
Temperature life 高温老化	Temperature : 105°C Duration : 250H 温度: 105°C 时间: 250H	Contact resistance: Initial value/ 5 mΩ max After environmental tests/ 10 mΩ max. 接触电阻: 初始值 5 mΩ 以下 测试后 10 mΩ 以下
Salt Spray 盐雾	Temperature:35±2°C Humidity:95~98%(R.H) PHValue : 6.5 ~ 7.2 Duration : 96 hours 温度: 35±2° C 湿度: 95~98%(R.H) PH值: 6.5~7.2 时间: 96 H	Contact resistance: Initial value/ 5 mΩ max After environmental tests/ 10 mΩ max. 接触电阻: 初始值 5 mΩ 以下 测试后 10 mΩ 以下
Durability(Mating/un-mating) 插拔寿命	25cycles 循环25次	Contact resistance: Initial value/ 5 mΩ max After environmental tests/ 10 mΩ max. 接触电阻: 初始值 5 mΩ 以下 测试后 10 mΩ 以下

WD6000 Series

Order Information 订购信息

Circuit 芯数	Part number 型号		Plating 电镀	Package 包装 Q'ty/Tube 只/管装	Remake 可量产 状态
	Key-X	Key-Y			
2	WD6000-1WR02W4BT11	WD6000-1WR02W4BT12	W4: W4=15u"Gold/Matte Tin	36	*

Note: * stands for mass production . 注: *代表可量产

Dimensions 尺寸 (R/A DIP)

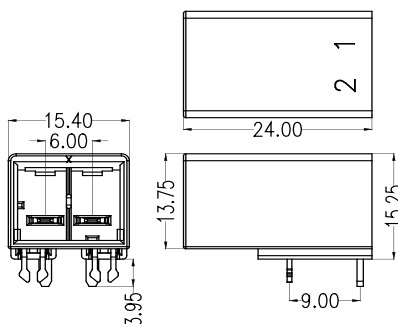

Assembly Schematic 装配示意

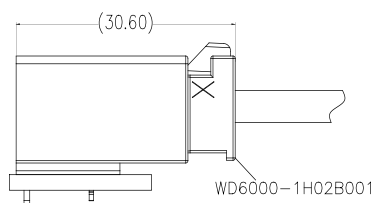

PCB Layout 印刷电路板布局

DIP type 通孔焊接型

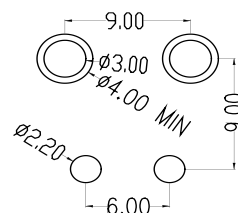

Key Layout Guide 键位说明

KEY	X	Y
KEY LOCATION		UNDETERMINED

Dimensions 尺寸

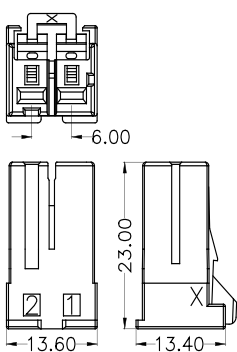

Order Information 订购信息

Circuit 芯数	Part number 型号		Package 包装 Q'ty/Bag 只/袋装	Remake 可量产 状态
	Key-X	Key-Y		
2	WD6000-1H02B001	/	1000	*

Note: * stands for mass production . 注: *代表可量产

Adaptor Terminal 适配端子

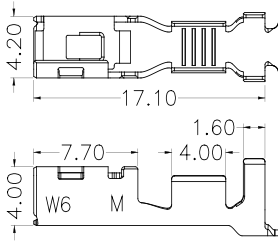

Part number 型号	Suitable wire diameter 适配线径
WD6350-3TD420S401	20~22AWG
WD6350-3TD416S401	16~20AWG
WD6350-3TD414S401	14~16AWG
WD6350-3TD412S401	12~14AWG

Terminal Crimping Specification 端子压接规范

型号 Model number	电线类型 Wire type	电线规格 Wire size	线缆 OD (mm) Cable OD (mm)	剥线长度 (mm) Strip length (mm)	导体铆压 (A-A) Conductor crimp		导体铆压 (B-B) Conductor crimp	
					压接宽度CBm1 Crimping height CBm1±0.05mm	压接高度 Crimping height CH1±0.03mm	压接宽度CBm2 Crimping width CBm2±0.05mm	压接高度CH2 Crimping width CH2±0.08mm
WD6350-3TD420S401 (SS Type)	0.34-0.37mm ²	22AWG	1.58-2.38	5.15±0.25	2.03	1.06	3.30	2.38 Max
	0.52-0.56mm ²	20AWG	1.76-2.56			1.13		2.56 Max
WD6350-3TD416S401 (S Type)	0.5-0.6mm ²	20AWG	1.8-3.23		2.79	1.18	3.56	3.23 Max
	0.81-0.96mm ²	18AWG				1.28		
	1.23-1.42mm ²	16AWG				1.41		
WD6350-3TD414S401 (M Type)	1.23-1.38mm ²	16AWG	2.0-3.75		2.79	1.54	4.06	3.75 Max
	2.08-2.18mm ²	14AWG				1.79		
WD6350-3TD412S401 (L Type)	2.08-2.18mm ²	14AWG	2.9-4.2		3.05	1.90	4.83	4.20 Max
	3.09-3.62mm ²	12AWG				2.17		

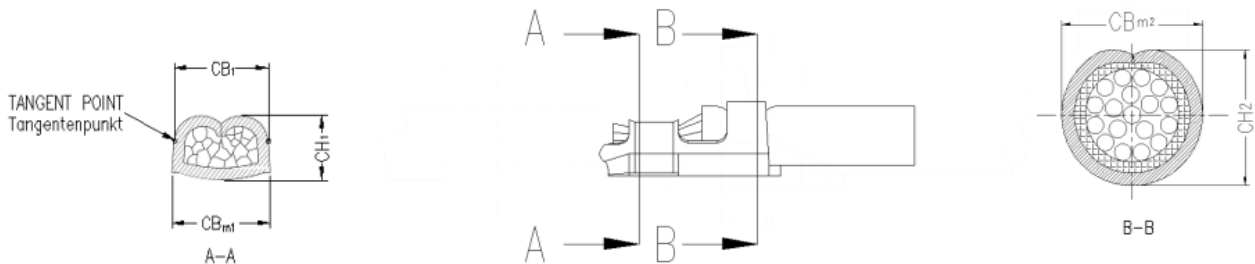

WD6000 Series

Model Numbering 型号命名

WD6000	-	1	WR	02	W4	B	T	1X
(1)		(2)	(3)	(4)	(5)	(6)	(7)	(8)
(1) Series (系列): 6.00mm Dyn Series				(5) Contact Plating (电镀): W4=15u" Gold /Matte Tin、				
(2) Number of rows (排数): 1=Single Row				(6) Color(颜色): B=Black				
(3) Terminal type (端子形态): WR=R/A DIP				(7) Packing (包装): T=Tube				
(4) Positions (位数): 02=2P				(8) Running number (流水码): 11=Key-X、12=Key-Y				

WD6000	-	1	H	02	B	0	0X
(1)		(2)	(3)	(4)	(5)	(6)	(7)
(1) Series (系列): 6.00mm Dyn Series				(5) Color(颜色): B=Black			
(2) Number of rows (排数): 1=Single Row				(6) Packing (包装): 0=PE Bag			
(3) Product type (产品类型): H=Crimp Type Housing				(7) Running number (流水码): 01=Key-X、02=Key-Y			
(4) Positions (位数): 02=2P							

Contact Us 联系我们

维峰电子股份有限公司(总部)
WCON ELECTRONICS CO.,LTD(HQ)
地址:广东省东莞市虎门镇大宁文明路15号
Add :No.15,Wenming Road,Daning Community, Humen Town,
Dongguan, Guangdong,523930, China

昆山维康电子有限公司
KUNSHAN WCON ELECTRONICIS CO.,LTD(East of China)
地址:江苏昆山市千灯镇汶浦中路169号
Add : No.169, WenPu Middle Road, QianDeng Town, Kunshan
City, Jiangsu Province, China

合肥维峰电子有限公司
HEFEI WCON ELECTRONICIS CO.,LTD
地址:安徽合肥市高新技术开发区绿城科技园E栋2楼
Add : 2F, Building E, Greentown Science Park,High-tech Develop-
ment Zone, Hefei, Anhui,China

维康电子(泰国)有限公司
WCON ELECTRONICS (Thailand) CO.,LTD
地址:泰国巴真武里府西玛铺县华瓦区洛加纳工业园
Add: VG3C+H57, Hua Wa, Si Maha Phot District, Prachin Buri
25140, Thailand

销售联系方式 Sales Contacts

国际客户部 International Sales Department
salesdg01@wcon.com
salesdg05@wcon.com

大客户专线 Key Account Line
华南: salesdg28@wcon.com
华东: salesks@wcon.com

中小客户专线 Small and Medium-sized Account Line
华南: salesdg10@wcon.com
华东: salesks01@wcon.com

网络销售 Online sales
salesdg26@wcon.com



Official Website



Product e-catalog



WeChat Public#



TikTok Public#