

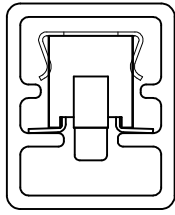

# HSF Packing:



## Tube:



W/T CAP

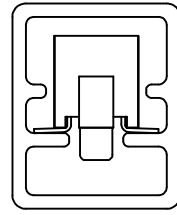

W/O CAP

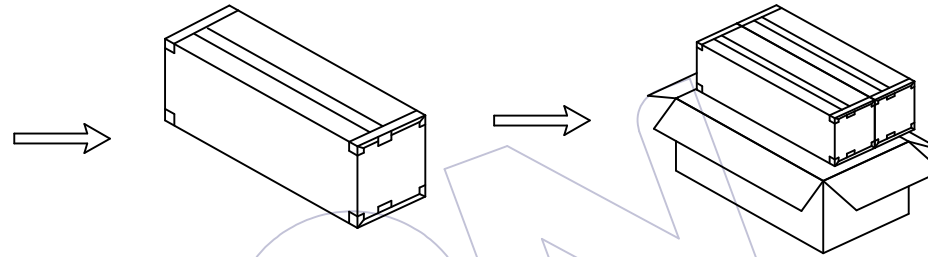

Inner Box

Box

## Reel:

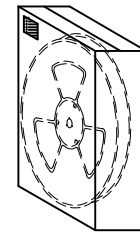
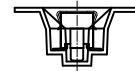
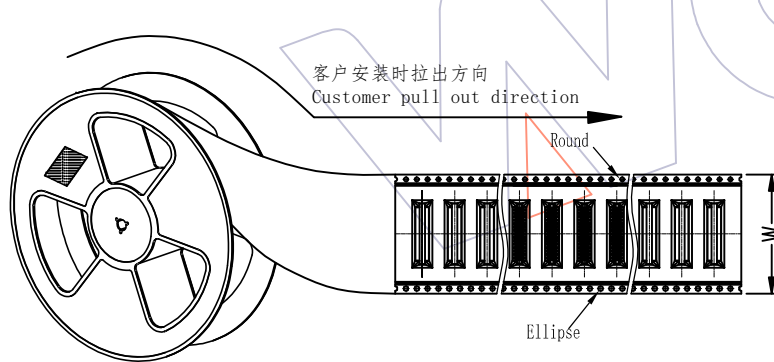

Inner Box

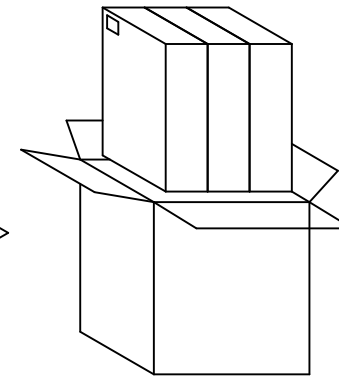

Box (Put in 3 Inner Box)

B0	2026/01/14	Standardization Drawing	BAO	OPERATION	DRAW	DATE	SCALE	FIT	PART NO.	 <a href="http://www.wcon.com">Http: www.wcon.com</a> WCON-Dongguan Tel: +86 769 85358920 WCON-Kunshan Tel: +86 512 57468408 Fax: +86 769 85358915 Fax: +86 512 57468468 E-mail: sales@wcon.com E-mail: salesks@wcon.com
A5	2023/02/03	Modify Flatness	XSR	x.x ±0.40	BAO	2026/01/14	UNIT	mm	2334-2XXMXXCUNX3	
A4	2016/06/17	Modify CAP 3.00 → 3.40	-----	x.xx ±0.25	CHECK	DATE	SIZE	A4	TITLE:	
A0	2012/07/06	NEW	-----	x.xxx ±0.15	TANG	2026/01/14	SHEET	2/3	1.27mm Female Header DUAL ROW SMT WITH DIFFERENT POST AND CAP H=3.40	
REV	DATE	MODIFICATION DESCRIPTION	CHANGE	Angle ± 3' DIM TOL	APPROVE Steven Zhao	DATE 2026/01/14	PROJ.	Customer NO.		

**HSF**

## Packaging Quantity Refers To The Following Table

PINS /Row	Q' ty/Tube	Q' ty/Inner Box	Q' ty/Box	PINS /Row	Q' ty/Tube	Q' ty/Inner Box	Q' ty/Box	PINS /Row	W	Q' ty/Reel	Q' ty/Inner Box	Q' ty/Box	PINS /Row	W	Q' ty/Reel	Q' ty/Inner Box	Q' ty/Box
2	500/Tray	/	24,000	27	15	4,800	9,600	2	16	1,050	4,200	12,600	27	56	1,050	1,050	3,150
3	83	26,560	53,120	28	14	4,480	8,960	3	16	1,050	4,200	12,600	28	56	1,050	1,050	3,150
4	70	22,400	44,800	29	14	4,480	8,960	4	24	1,050	3,150	9,450	29	56	1,050	1,050	3,150
5	61	19,520	39,040	30	14	4,480	8,960	5	24	1,050	3,150	9,450	30	56	1,050	1,050	3,150
6	54	17,280	34,560	31	13	4,160	8,320	6	24	1,600	4,800	14,400	31	56	1,050	1,050	3,150
7	48	15,360	30,720	32	13	4,160	8,320	7	24	1,050	3,150	9,450	32	56	1,050	1,050	3,150
8	43	13,760	27,520	33	12	3,840	7,680	8	24	1,050	3,150	9,450	33	72	1,050	1,050	3,150
9	39	12,480	24,960	34	12	3,840	7,680	9	24	1,050	3,150	9,450	34	72	1,050	1,050	3,150
10	36	11,520	23,040	35	12	3,840	7,680	10	32	1,600	3,200	9,600	35	72	1,050	1,050	3,150
11	33	10,560	21,120	36	11	3,520	7,040	11	32	1,050	2,100	6,300	36	72	1,050	1,050	3,150
12	31	9,920	19,840	37	11	3,520	7,040	12	32	1,050	2,100	6,300	37	72	1,050	1,050	3,150
13	29	9,280	18,560	38	11	3,520	7,040	13	32	1,050	2,100	6,300	38	72	1,050	1,050	3,150
14	27	8,640	17,280	39	11	3,520	7,040	14	44	1,050	2,100	6,300	39	72	1,050	1,050	3,150
15	26	8,320	16,640	40	10	3,200	6,400	15	44	1,050	2,100	6,300	40	72	1,050	1,050	3,150
16	24	7,680	15,360	41	10	3,200	6,400	16	44	1,050	2,100	6,300	41	72	1,050	1,050	3,150
17	23	7,360	14,720	42	10	3,200	6,400	17	44	1,050	2,100	6,300	42	72	1,050	1,050	3,150
18	22	7,040	14,080	43	10	3,200	6,400	18	44	1,050	2,100	6,300	43	72	1,050	1,050	3,150
19	21	6,720	13,440	44	9	2,880	5,760	19	44	1,050	2,100	6,300	44	72	1,050	1,050	3,150
20	20	6,400	12,800	45	9	2,880	5,760	20	44	1,050	2,100	6,300	45	72	1,050	1,050	3,150
21	19	6,080	12,160	46	9	2,880	5,760	21	44	1,050	2,100	6,300	46	88	1,050	1,050	3,150
22	18	5,760	11,520	47	9	2,880	5,760	22	44	1,050	2,100	6,300	47	88	1,050	1,050	3,150
23	17	5,440	10,880	48	9	2,880	5,760	23	44	1,050	2,100	6,300	48	88	1,050	1,050	3,150
24	17	5,440	10,880	49	8	2,560	5,120	24	56	1,050	1,050	3,150	49	88	1,050	1,050	3,150
25	16	5,120	10,240	50	8	2,560	5,120	25	56	1,050	1,050	3,150	50	88	1,050	1,050	3,150
26	16	5,120	10,240					26	56	1,050	1,050	3,150					

B0	2026/01/14	Standardization Drawing	BAO	OPERATION	DRAW	DATE	SCALE	FIT	PART NO.	 <a href="http://www.wcon.com">Http: www.wcon.com</a> WCON-Dongguan Tel: +86 769 85358920 Fax: +86 769 85358915 E-mail: sales@wcon.com WCON-Kunshan Tel: +86 512 57468408 Fax: +86 512 57468468 E-mail: sales@wcon.com
A5	2023/02/03	Modify Flatness	XSR	x.X ±0.40	BAO	2026/01/14	UNIT	mm	2334-2XXMXXCUNX3	
A4	2016/06/17	Modify CAP 3.00 → 3.40	-----	x.XX ±0.25	CHECK	DATE	SIZE	A4	TITLE:	
A0	2012/07/06	NEW	-----	x.XXX ±0.15	TANG	2026/01/14	SHEET	3/3	1.27mm Female Header DUAL ROW SMT WITH DIFFERENT POST AND CAP H=3.40	
REV	DATE	MODIFICATION DESCRIPTION	CHANGE	Angle ± 3'	APPROVE	DATE	PROJ.	Customer NO.		