

HSF

NOTES: $\Delta 3$

Rated Current: 1.5AMP.(20°C,2*2P-2*15P)

1.0AMP.(20°C,2*16P-2*50P)

Contact Resistance: 20mΩ Max.

Withstand Voltage: 500V AC/DC

Insulation Resistance: 1000MΩ Min.

Operation Temperature: -40°C to +125°C(Gold Plating)

-40°C to +105°C(Tin Plating)

Contact Material: Copper Alloy

Contact Plating: Au or Sn Over 30u" Min Ni

Insulator Material: PA9T+G.F UL94V-0 BK

Recommended P.C.B Layout(Top Side)
(PCB BOARD TOLERANCE±0.05)
(PCB Thickness: T=1.60m)

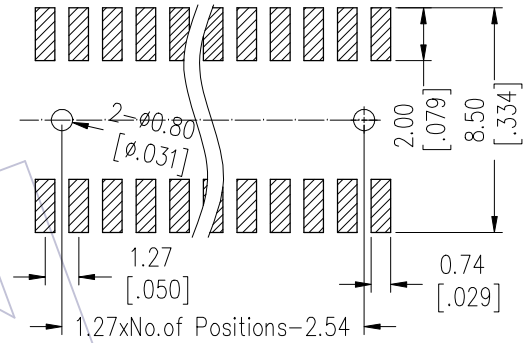
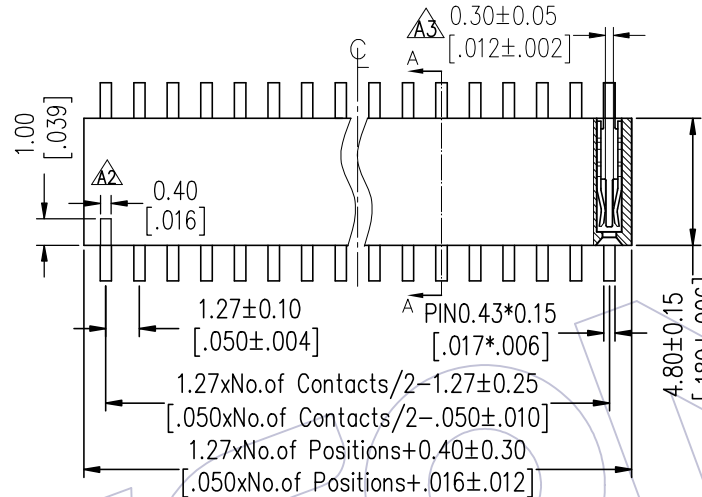

Ordering Information $\Delta 3$

2335- 2 XX M XX C U N X X

Plastic Row
No. of Pins Per Row: 02-50
Welding Type: M=SMT
Contact Plating: G0=Gold Flash, G3=10u"Au, BG3=8u"PdNi+2u"Au, G4=15u"Au, BG4=13u"PdNi+2u"Au, G5=30u"Au, BG5=28u"PdNi+2u"Au, S0=Gold Flash/Tin, S3=10u"Au/Sn, P3=8u"PdNi+2u"Au/Sn, S4=15u"Au/Sn, P4=13u"PdNi+2u"Au/Sn, S5=30u"Au/Sn, P5=28u"PdNi+2u"Au/Sn, SN=Bright Tin

Series No. 1=W/O Post, 2=W/T Post
Packing: T=Tube, R=Tape&Reel
Logo: N=W/O Logo
Contact Type: U=U Type
Insulator Material: C=PA9T

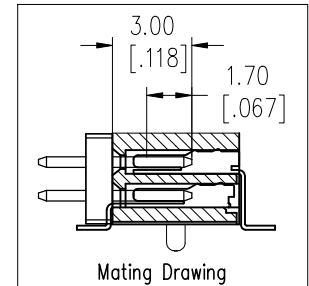
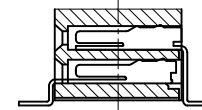
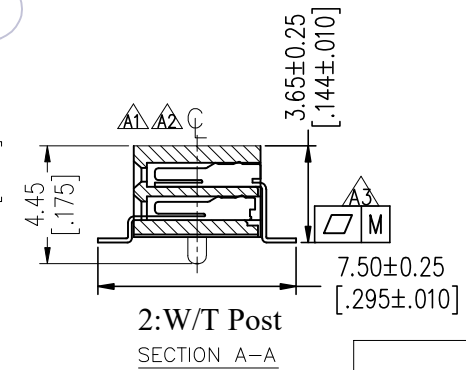
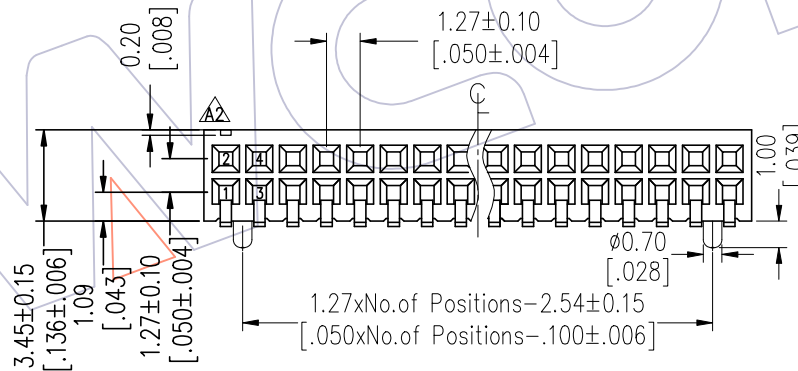

Item	Pitch	Mating	DIM.B
Standard	1.27	1310/1315/1320	3.00
Alternate			

$\Delta 3$ Pin(Per Row)	2-15P	16-30P	31-50P
M	0.10	0.15	0.18

REV	DATE	MODIFICATION DESCRIPTION	CHANGE	DIM	TOL	APPROVE	DATE	PROJ.	PART NO.	TITLE:	Customer NO.
A4	2026/02/02	Standardization Drawing	BAO			STEVEN ZHAO	2026/02/02		2335-2XXMXXCUNXX	1.27mm Female Header DUAL SIDE INSERT SMT H=3.45	
A3	2023/02/03	ADD Flatness	XSR	x.x	±0.40	TANG	2026/02/02				
A2	2017/04/19	Cancel Mylar, Modify plastic	-----	x.xx	±0.25		2026/02/02				
A0	2012/07/09	NEW	-----	x.xxx	±0.15		2026/02/02				
				Angle	± 3'	STEVEN ZHAO	2026/02/02				

WCON
Http: www.wcon.com

WCON-Dongguan
Tel: +86 769 85358920
Fax: +86 769 85358915
E-mail: sales@wcon.com

WCON-Kunshan
Tel: +86 512 57468408
Fax: +86 512 57468468
E-mail: salesks@wcon.com

HSF

Packing: 

Tube:

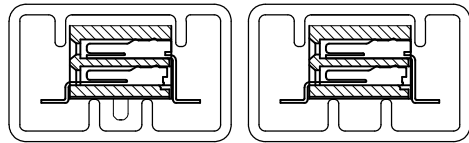

W/T Post

W/O Post

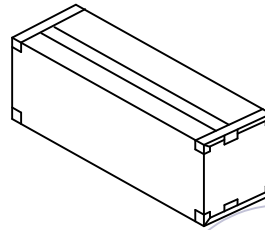

Inner Box

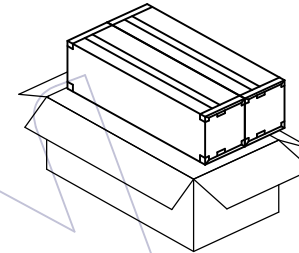

Box

Reel:

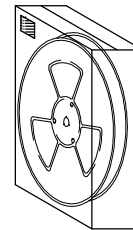
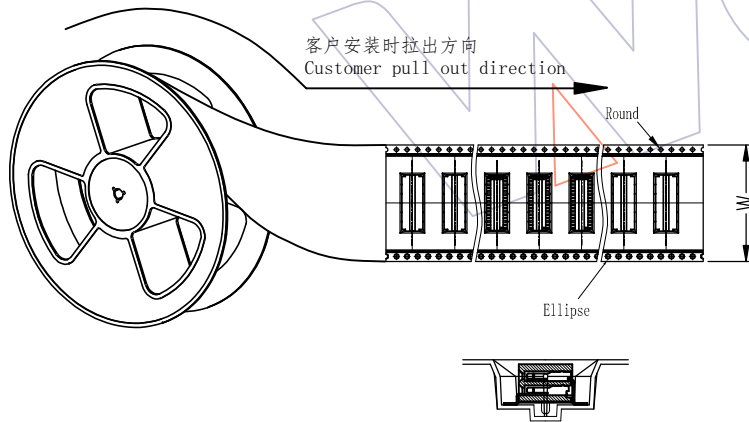

Inner Box

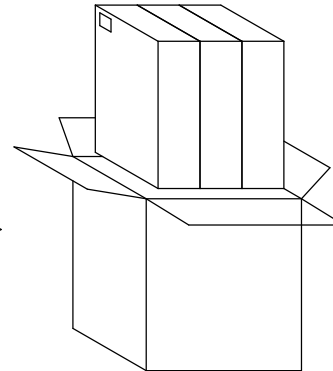

Box (Put in 3 Inner Box)

A4	2026/02/02	Standardization Drawing	BAO	OPERATION	DRAW	DATE	SCALE	FIT	PART NO. 2335-2XXMXXCUNXX
A3	2023/02/03	ADD Flatness	XSR	x.x ±0.40	BAO	2026/02/02	UNIT	mm	
A2	2017/04/19	Cancel Mylar,Modify plasitc	-----	x.xx ±0.25	CHECK	DATE	SIZE	A4	TITLE: 1.27mm Female Header DUAL SIDE INSERT SMT H=3.45
A0	2012/07/09	NEW	-----	x.xxx ±0.15	TANG	2026/02/02	SHEET	2/3	
REV	DATE	MODIFICATION DESCRIPTION	CHANGE	Angle ± 3°	APPROVE	DATE	PROJ.	Customer NO.	
				DIM TOL	Steven Zhao	2026/02/02			

WCON

Http: www.wcon.com

WCON-Dongguan
Tel: +86 769 85358920
Fax: +86 769 85358915
E-mail: sales@wcon.com

WCON-Kunshan
Tel: +86 512 57468408
Fax: +86 512 57468468
E-mail: salesks@wcon.com

HSF

Packaging Quantity Refers To The Following Table

PINS /Row	Q' ty/Tube	Q' ty/Inner Box	Q' ty/Box	PINS /Row	Q' ty/Tube	Q' ty/Inner Box	Q' ty/Box	PINS /Row	W	Q' ty/Reel	Q' ty/Inner Box	Q' ty/Box	PINS /Row	W	Q' ty/Reel	Q' ty/Inner Box	Q' ty/Box
2	800/Tray	/	38,400	27	16	3,840	7,680	2	16	800	3,200	9,600	27	56	800	800	2,400
3	137	32,880	65,760	28	16	3,840	7,680	3	16	800	3,200	9,600	28	56	800	800	2,400
4	105	25,200	50,400	29	15	3,600	7,200	4	16	800	3,200	9,600	29	56	800	800	2,400
5	85	20,400	40,800	30	15	3,600	7,200	5	24	800	2,400	7,200	30	56	800	800	2,400
6	72	17,280	34,560	31	14	3,360	6,720	6	24	800	2,400	7,200	31	56	800	800	2,400
7	62	14,880	29,760	32	14	3,360	6,720	7	24	800	2,400	7,200	32	56	800	800	2,400
8	54	12,960	25,920	33	13	3,120	6,240	8	24	800	2,400	7,200	33	56	800	800	2,400
9	49	11,760	23,520	34	13	3,120	6,240	9	24	800	2,400	7,200	34	56	800	800	2,400
10	44	10,560	21,120	35	12	2,880	5,760	10	32	800	1,600	4,800	35	56	800	800	2,400
11	40	9,600	19,200	36	12	2,880	5,760	11	32	800	1,600	4,800	36	72	800	800	2,400
12	37	8,880	17,760	37	12	2,880	5,760	12	32	800	1,600	4,800	37	72	800	800	2,400
13	34	8,160	16,320	38	11	2,640	5,280	13	32	800	1,600	4,800	38	72	800	800	2,400
14	31	7,440	14,880	39	11	2,640	5,280	14	32	800	1,600	4,800	39	72	800	800	2,400
15	29	6,960	13,920	40	11	2,640	5,280	15	32	1,000	2,000	6,000	40	72	800	800	2,400
16	27	6,480	12,960	41	10	2,400	4,800	16	44	800	1,600	4,800	41	72	800	800	2,400
17	26	6,240	12,480	42	10	2,400	4,800	17	44	800	1,600	4,800	42	72	800	800	2,400
18	25	6,000	12,000	43	10	2,400	4,800	18	44	800	1,600	4,800	43	72	800	800	2,400
19	23	5,520	11,040	44	10	2,400	4,800	19	44	800	1,600	4,800	44	72	800	800	2,400
20	22	5,280	10,560	45	10	2,400	4,800	20	44	800	1,600	4,800	45	72	800	800	2,400
21	21	5,040	10,080	46	9	2,160	4,320	21	44	800	1,600	4,800	46	72	800	800	2,400
22	20	4,800	9,600	47	9	2,160	4,320	22	44	800	1,600	4,800	47	72	800	800	2,400
23	19	4,560	9,120	48	9	2,160	4,320	23	44	800	1,600	4,800	48	72	800	800	2,400
24	18	4,320	8,640	49	9	2,160	4,320	24	56	800	800	2,400	49	88	800	800	2,400
25	18	4,320	8,640	50	9	2,160	4,320	25	56	800	800	2,400	50	88	800	800	2,400
26	17	4,080	8,160					26	56	800	800	2,400					

A4	2026/02/02	Standardization Drawing	BAO	OPERATION		DRAW	DATE	SCALE	FIT	PART NO.		 Http: www.wcon.com WCON-Dongguan Tel: +86 769 85358920 Fax: +86 769 85358915 E-mail: sales@wcon.com WCON-Kunshan Tel: +86 512 57468408 Fax: +86 512 57468468 E-mail: salesks@wcon.com
A3	2023/02/03	ADD Flatness	XSR	x.x	±0.40	BAO	2026/02/02	UNIT	mm	2335-2XXMXXCUNXX		
A2	2017/04/19	Cancel Mylar,Modify plasitc	-----	x.xx	±0.25	CHECK	DATE	SIZE	A4	TITLE:		
A0	2012/07/09	NEW	-----	x.xxx	±0.15	TANG	2026/02/02	SHEET	3/3	1.27mm Female Header DUAL SIDE INSERT SMT H=3.45		
REV	DATE	MODIFICATION DESCRIPTION	CHANGE	Angle	± 3'	APPROVE	DATE	PROJ.	Customer NO.			
				DIM	TOL	Steven Zhao	2026/02/02					